



# MAX1895 Evaluation Systems

Evaluate: MAX1895/MAX1995

## General Description

The MAX1895 evaluation systems are assembled and tested PC boards that demonstrate the MAX1895 high-efficiency, wide brightness range CCFL backlight controller. The MAX1895EVSYS-S is designed for single-lamp applications and the MAX1895EVSYS-D is designed for dual-lamp applications. Both systems can control the brightness of the lamps through either the SMBus interface or by an on-board potentiometer.

The systems include a Maxim SMBus™ interface board (MAXSMBUS), which allows an IBM-compatible PC to use its parallel port to emulate an Intel system management bus (SMBus) I<sup>2</sup>C™ interface. Windows 95/98®-compatible software provides a user-friendly interface to exercise the features of the MAX1895. The program is menu-driven and offers a graphic interface with control buttons and status display.

**Note:** Windows NT/2000 requires additional driver software; contact the factory.

To evaluate the performance of the MAX1895, configure the MAX1895EVSYS for analog interface mode. There is no need to change the IC since the MAX1895's performance is identical to the MAX1995's performance. See *Detailed Description of Hardware*, Table 2 and Table 3.

## Component Suppliers

SUPPLIER	PHONE	FAX
Diodes Inc.	805-446-4800	805-446-4850
Fairchild	888-522-5372	972-910-8036
General Semiconductor	760-804-9258	760-804-9259
International Rectifier	310-322-3331	310-252-7175
Murata	770-436-1300	770-436-3030
Sumida	847-956-0666	847-956-0702
Taiyo Yuden	800-348-2496	847-925-0899
TDK	847-803-6100	847-390-4405
Toko	847-297-0070	847-699-1194
Toshiba	949-455-2000	949-859-3963

**Note:** Please indicate you are using the MAX1895 when contacting these manufacturers.

SMBus is a trademark of Intel Corp.

Windows is a registered trademark of Microsoft Corp.

I<sup>2</sup>C is a trademark of Philips Corp.

## Features

- ◆ Single Lamp Application (MAX1895EVSYS-S)
- ◆ Dual Lamp Application (MAX1895EVSYS-D)
- ◆ 7V to 24V Input Range
- ◆ Wide Brightness Adjustment Range
- ◆ Open Lamp Protection with 2s Timeout
- ◆ Brightness Adjustable through SMBus Interface or On-Board Potentiometer
- ◆ No Flicker at Low Brightness
- ◆ High Power-to-Light Efficiency
- ◆ I<sup>2</sup>C/SMBus Compatible
- ◆ Easy to Use Menu-Driven Software
- ◆ Assembled and Tested
- ◆ Includes: Windows 95/98-Compatible Software (3.5in Floppy Disk) and Demo PC Board

## Ordering Information

PART	TEMP RANGE	NUMBER OF LAMPS
MAX1895EVSYS-S	0°C to +70°C	1
MAX1895EVSYS-D	0°C to +70°C	2

## MAX1895EVSYS-S Component List

PART	QTY	DESCRIPTION
MAX1895EVKIT-S	1	MAX1895 evaluation kit (for single-lamp application)
MAXSMBUS	1	Interface board

## MAX1895EVSYS-D Component List

PART	QTY	DESCRIPTION
MAX1895EVKIT-D	1	MAX1895 evaluation kit (for dual-lamp application)
MAXSMBUS	1	Interface board



# MAX1895 Evaluation Systems

Evaluate: MAX1895/MAX1995

## MAX1895EVKIT Component List

DESIGNATION	QTY	DESCRIPTION
C1, C13, C14, C17	4	See Table 4
C2, C4, C6, C9, C10	5	0.1 $\mu$ F, 10V, X5R ceramic capacitors Murata GRP155R61A104K Taiyo Yuden LMK105BJ104MV TDK C1005X5R1A104K
C3	1	100pF, 50V, NPO ceramic capacitor
C5	1	0.01 $\mu$ F, 16V, X7R ceramic capacitor
C7	1	0.022 $\mu$ F, 16V, X7R ceramic capacitor
C8	1	15pF, 3.1kV, ceramic high-voltage capacitor Murata GRM42D1X3F150J TDK C4520C0G3F150K
C11	1	1 $\mu$ F, 25V, X7R ceramic capacitor Murata GRM31MR71E105K Taiyo Yuden TMK316BJ105KL TDK C3216X7R1E105K
C12	0	Not installed (Use two 0.47 $\mu$ F, 25V capacitors for C11 and C12 to lower ESR and increase efficiency)
C15	1	0.1 $\mu$ F, 25V, X7R ceramic capacitor TDK C1608X7R1E104K
C16	1	0.47 $\mu$ F, 10V, X5R ceramic capacitor Taiyo Yuden LMK107BJ474KA TDK C1 $\mu$ 608X5R1A474K
C18	1	0.01 $\mu$ F, 50V, X7R ceramic capacitor
D1, D4, D5, D6	4	See Table 4
D2	1	100mA dual Schottky diode—common anode Diodes Incorporated BAT54AW Central Semiconductor CMSSH-3A

DESIGNATION	QTY	DESCRIPTION
D3	1	Diode, 1N4148-type Fairchild MM5D4148 General Semiconductor 1N4148W Diodes Incorporated 1N4148W
J1	1	2 $\times$ 10 right angle female receptacle
JU1, JU8	0	Not installed
JU2, JU3	2	4-pin headers 'T'
JU4, JU6, JU7	3	3-pin headers
JU5	1	2-pin header
M1	1	See Table 4
N1A/B, N2A/B	2	See Table 4
R1	1	100k $\Omega$ $\pm$ 1% resistor
R2, R8	0	Not installed
R3	1	100k $\Omega$ $\pm$ 1% resistor
R4	1	49.9k $\Omega$ $\pm$ 1% resistor
R5, R6, R9, R10	4	10k $\Omega$ $\pm$ 5% resistors
R7	1	10k $\Omega$ potentiometer (multiturn)
R11	1	150 $\Omega$ $\pm$ 1% resistor (0603)
R12	2	2k $\Omega$ $\pm$ 5% resistor (0603)
R13–R17	5	See Table 4
T1	1	Transformer 93:1 Toko T912MG-1018 (BLC103B style)
T2	1	See Table 4
U1	1	MAX1895EGI
None	5	Shunts for JU2 (1-3), JU3 (1-4), JU4 (1-2), JU6 (1-2), JU7 (1-2)

# MAX1895 Evaluation Systems

Evaluate: MAX1895/MAX1995

## Quick Start

### Required Equipment

Before you begin you will need the following equipment:

- An IBM PC-compatible computer running Windows 95/98
- A parallel printer port (this is a 25-pin socket on the back of the computer)
- A standard 25-pin, straight-through, male-to-female cable to connect the computer's parallel port to the Maxim SMBus interface board
- A DC power supply capable of supplying any voltage between 7V to 20V at 100mA to power the SMBus board
- A DC power supply capable of supplying a voltage between 7V to 24V at 2A to power the MAX1895 board
- A CCFL lamp with the following specifications:
  - Maximum Strike Voltage  $\leq 1.2\text{kV}$
  - Lamp Current  $\leq 6\text{mA}$
  - Input Power  $\leq 4\text{W}$

**Note:** Analog interface operation requires only a power supply (between 7V to 24V at 2A) and a CCFL lamp.

**WARNING! High voltages are present on this evaluation kit. Use caution when making connections and applying power.**

### Procedure

- 1) Carefully connect the boards by aligning the 20-pin connector of the MAX1895 EV kit with the 20-pin header of the MAXSMBUS interface board. Gently press them together. The two boards should be flush against each other.
- 2) Do not turn on the power until all connections are made.
- 3) Connect the lamp to the high-voltage pads.
- 4) Set the jumpers to the following position:

JU1	Open
JU2	1-3
JU3	1-4
JU4	1-2
JU5	Open
JU6	1-2
JU7	1-2

- 5) Connect a cable from the computer's parallel port to the SMBus interface board. Use a straight-through 25-pin female-to-male cable. To avoid damaging the EV kit or your computer, do not use a 25-pin SCSI port or any other connector that is physically similar to the 25-pin parallel printer port.
- 6) The MAX1895.EXE software program can be run from the floppy or hard drive. Simply use the Windows program manager to run the program. If desired, you may use the INSTALL.EXE program to copy the files and create icons for them in the Windows 95/98 Start Menu. An uninstall program is included with the software. Simply click on the UNINSTALL icon to remove the EV kit software from the hard drive.
- 7) Connect a 7V to 20V DC power supply to the pads labeled POS9 and GND1 of the SMBus interface board.
- 8) Connect the 12V supply to the pads labeled VIN and GND.
- 9) Turn on both power supplies.
- 10) Start the MAX1895 program by opening its icon in the Start Menu.
- 11) Observe as the program automatically detects the address of the MAX1895 and starts the main program.

## Detailed Description of Software

### User-Interface Panel

The user interface is easy to operate using the mouse, or by using the tab key to navigate with the arrow keys. Each of the buttons corresponds to bits in the command and configuration bytes. Clicking on them generates the correct SMBus write operation to update the internal registers.

The brightness of the lamp can be adjusted by either moving the trackbar or by entering a value between 0 and 31 into the edit field located below the trackbar. Pressing enter after typing in the new value updates the internal register.

The SHMD register configures the operation of the device as described in Table 1.

When the Automatic Read feature is enabled, the program polls the MAX1895 twice a second. The brightness, mode, and status are read and the appropriate fields are updated on the main display. Unchecking the checkbox can disable this feature and each field can be updated individually by clicking the appropriate button.

# MAX1895 Evaluation Systems

The Brightness Cycle feature cycles the brightness through its entire range.

The Status register indicates whether the lamp circuit has opened (Status1 low) or an overcurrent condition has occurred (Status0 low).

The RESET button will set the MAX1895 and software to the POR state. If in doubt, click the reset button.

### Simple SMBus Commands

There are two methods for communicating with the MAX1895: through the normal user-interface panel, or through the SMBus commands available from pressing the MAXSMBUS button. A display pops up that allows the SMBus protocols, such as Read Byte and Write Byte, to be executed. To stop normal user-interface execution so that it does not override the manually set values, turn off the timer by unchecking the Automatic Read checkbox.

The SMBus dialog boxes accept numeric data in binary, decimal, or hexadecimal. Hexadecimal numbers should be prefixed by \$ or 0x. Binary numbers must be exactly 8 digits.

### Detailed Description of Hardware

#### Jumper JU1

Jumper JU1 connects the current limit pin (ILIM) to VCC.

With the shunt installed, the current limit is set to:

$$\frac{0.2V}{R_{DS(ON)} \text{ of N1}}$$

With the shunt removed, the current limit is determined by the  $R_{DS(ON)}$  of MOSFET N1 and the resistor-divider

formed by R1 and R2. Use the equation shown below to calculate the current limit:

$$\text{Current Limit (A)} = \frac{1}{5} \times \frac{2V \times \frac{R2}{R1 + R2}}{R_{DS(ON)} \text{ of N1}}$$

The MAX1895 EV kit (single lamp) is shipped with R1 = 100k $\Omega$ , R2 open, and  $R_{DS(ON)}$ -TYPICAL = 0.113 $\Omega$ . The dual lamp has an  $R_{DS(ON)}$ -TYPICAL = 0.044 $\Omega$ .

#### Jumper JU2

Jumper JU2 sets the voltage on the MINDAC pin. This voltage sets the DAC's minimum scale output voltage, which sets the lamp brightness for the minimum DAC code.

In the 1-2 position, MINDAC is connected to VCC. In this position, the lamp is completely off at the minimum scale. Additionally, the DPWM dimming function is disabled (refer to the MAX1895 data sheet).

In the 1-3 position, MINDAC is connected to REF through a voltage-divider formed by R3 and R4. The voltage on MINDAC is approximately 0.67, allowing a minimum analog dimming range of 33% of maximum brightness. The DPWM dimming function still remains available.

In the 1-4 position, MINDAC is connected directly to REF. The voltage on MINDAC is 2V effectively disabling analog dimming. Only DPWM dimming is available.

#### Jumper JU3

Jumper JU3 sets the MAX1895 to either analog interface or SMBus interface. There are two possible settings in analog interface: negative scale and positive scale. In negative-scale analog interface (JU3 = 1-2), the brightness of the lamp decreases as the voltage on

**Table 1. SH/SUS and SHMD Register Truth Table**

SH/SUS	SHMD2	SHMD1	SHMD0	OPERATING MODE
0	0	X	0	Operate
0	0	X	1	Shutdown STATUS1 set
1	0	0	X	Operate
1	0	1	X	Shutdown STATUS1 set
X	1	X	X	Shutdown STATUS1 set

# MAX1895 Evaluation Systems

pin CTL/SCL increases. In positive-scale ADC interface (JU3 = 1-3), the brightness of the lamp increases as the voltage on pin CTL/SCL increases. Jumper (JU3 = 1-4) enables the SMBus interface on the MAX1895. Refer to the MAX1895 data sheet for more information.

### Jumper JU4

Jumper JU4 connects the CRF/SDA pin to VCC either directly (position 2-3) or through a 10kΩ resistor (position 1-2).

Position 1-2 is for SMBus operation. A 10kΩ pullup resistor is connected to the SMBus data signal.

To use the analog interface, connect JU4 to position 2-3. The CRF/SDA pin sets the full brightness reference for the CTL/SCL pin. Connecting this pin directly to VCC sets the full brightness reference voltage to 5.3V. To use a voltage other than 5.3V, leave JU4 open and apply an external voltage to the pad CRF/SDA.

### Jumpers JU5 and JU6

The jumper JU5 must be left open for SMBus operation to prevent loading to the SMBus data signal.

Jumper JU6, position 1-2, is for SMBus operation. A 10kΩ pullup resistor is connected to the SMBus clock signal. To use analog interface, install a shunt on JU5. This connects potentiometer R8 to the CRF/SDA pin voltage.

When using this mode, jumper JU6 must be installed in the 2-3 position. This connects the wiper of R8 to the CTL/SCL pin. Adjusting R8 changes the voltage on this pin, which changes the brightness of the lamp.

### Jumper JU7

Jumper JU7, position 1-2, enables the MAX1895 unless the SMBus suspend line (SH/SUS) pulls low.

In the 2-3 position, the MAX1895 is placed into shutdown mode.

### Jumper JU8

Jumper JU8 connects the power-supply input for the gate drivers (VDD), to the 5.3V linear regulator output (VCC).

To use a different voltage for the gate drivers, cut the trace shorting jumper JU8 and apply the desired voltage to the pad labeled VDD.

**Table 2. Jumper Settings Description**

JUMPER	SHUNT LOCATION	FUNCTION
JU1	Open*	Current limit is set by the resistor-divider formed by R1 and R2. (The MAX1895 EV kit is shipped with R1 = 100kΩ and R2 open.)
	Closed	Current limit is set to: $\frac{0.2V}{R_{DS(ON)} \text{ of } N1}$ Note: Remove R1 before installing the shunt.
JU2	1-2	MINDAC = VCC: disables the DPWM chopping function.
	1-3*	MINDAC ≅ 0.67V: MINDAC is connected to REF through a voltage-divider formed by R3 and R4. This voltage sets the DAC's minimum scale output voltage.
	1-4	MINDAC = 2V: MINDAC is connected to REF. Analog dimming is disabled.
JU3	1-2	MODE = REF: (negative-scale analog interface), CTL/SCL = 0V results in maximum brightness.
	1-3	MODE = GND: (positive-scale analog interface), CTL/SCL = 0V results in minimum brightness.
	1-4*	MODE = VCC: enable SMBus interface.
JU4	Open	Used for analog interface: drive CRF/SDA with an external voltage. The external voltage is the reference voltage. (JU3 must be in 1-2 or 1-3 position. JU5 = closed.)
	1-2*	Used for SMBus interface: CRF/SDA connected to VCC through 10kΩ pullup resistor.
	2-3	Used for analog interface: CRF/SDA = VCC. VCC is the full-brightness reference input voltage. (JU3 must be in 1-2 or 1-3 position. JU5 = closed.)

\*Default position.

# MAX1895 Evaluation Systems

Evaluate: MAX1895/MAX1995

**Table 2. Jumper Settings Description (continued)**

JUMPER	SHUNT LOCATION	FUNCTION
JU5	Open*	Used for SMBus interface: drive CRF/SDA with SMBus data.
	Closed	Used for analog interface: drive CRF/SDA with analog voltage. (Connect JU2 to 1-2 position to use VCC as the analog voltage.)
JU6	1-2*	Used for SMBus interface: CTL/SCL connected to VCC through 10kΩ pullup resistor.
	2-3	Used for analog interface: CTL/SCL connected to ADC reference input voltage (CRF/SDA) through potentiometer R8. Adjusting R8 changes the brightness.
JU7	1-2*	Used for SMBus mode: $\overline{SH}/SUS$ is connected to VCC through 10kΩ pullup resistor.
	2-3	Places the MAX1895 into shutdown.
JU8	Open	Drive VDD (power supply for the gate drivers) with an external power supply.
	Closed*	VDD is tied to VCC (pin 28, 5.3V linear regulator output).

\*Default position

**Table 3. Jumper Settings Quick Reference**

JUMPER	SMBUS DIGITAL INTERFACE	ANALOG INTERFACE
JU1	Open	Open
JU2	1-3	1-3
JU3	1-4	1-2 or 1-3
JU4	1-2	2-3
JU5	Open	Closed
JU6	1-2	2-3
JU7	1-2	1-2
JU8	Closed	Closed

# MAX1895 Evaluation Systems

Evaluate: MAX1895/MAX1995

**Table 4. Components Different Between the Single-Lamp and Dual-Lamp Boards**

DESIGNATION	MAX1895EVKIT-S (SINGLE LAMP)		MAX1895EVKIT-D (DUAL LAMP)	
	QTY	DESCRIPTION	QTY	DESCRIPTION
C1	1	4.7μF, 25V ceramic capacitor Taiyo Yuden TMK325BJ475MN TDK C3225X7R1E475M	1	10μF, 25V ceramic capacitor Taiyo Yuden TMK432BJ106MM TDK C4532X7R1E106M
C13	0	Not installed	1	0.1μF, 16V ceramic capacitor Murata GRM188R71C104K Taiyo Yuden EMK107BJ104KA TDK C1608X7R1C104K
C14	0	Not installed	1	15pF, 3kV high-voltage ceramic capacitor Murata GRM42D1X3F150J TDK C4520C0G3F150K
C17	0	Not installed	1	0.022μF, 16V ceramic capacitor Murata GRP155R71C223K Taiyo Yuden EMK105BJ223KV TDK C1005X7R1E223K
D1	1	1N4148-type diode Diodes Inc. MMBD4148 Fairchild Semiconductor MMBD4148 General Semiconductor IMBD4148	1	6.2V zener diode Central Semiconductor CMPZ5234B Diodes Inc. BZX84C6V2 Fairchild Semiconductor MMBZ5234B
D4	0	Not installed	1	6.2V zener diode Central Semiconductor CMPZ5234B Diodes Inc. BZX84C6V2 Fairchild Semiconductor MMBZ5234B
D5	0	Not installed	1	1N4148-type diode Diodes Inc. 1N4148W Fairchild Semiconductor MM5D4148 General Semiconductor 1N4148W
D6	0	Not installed	1	Dual Schottky common-cathode diode Central Semiconductor CMPSH-3C Diodes Inc. BAT54C Fairchild Semiconductor BAT54C General Semiconductor BAT54C
M1	0	Not installed	1	2N7002 MOSFET Central Semiconductor 2N7002 Diodes Inc. 2N7002 General Semiconductor 2N7002
N1, N2	2	Dual N-channel MOSFETs Fairchild Semiconductor FDC6561AN	2	Dual N-channel MOSFETs Fairchild Semiconductor FDS6930A
R13	0	Not installed	1	4.7kΩ ±5% resistor
R14	0	Not installed	1	20kΩ ±5% resistor
R15	0	Not installed	1	2kΩ ±5% resistor
R16, R17	2	0Ω resistors	0	Not installed
T2	0	Not installed	1	Transformer 93:1 Toko T912MG-1018 (BLC103B Style)

# MAX1895 Evaluation Systems

Evaluate: MAX1895/MAX1995

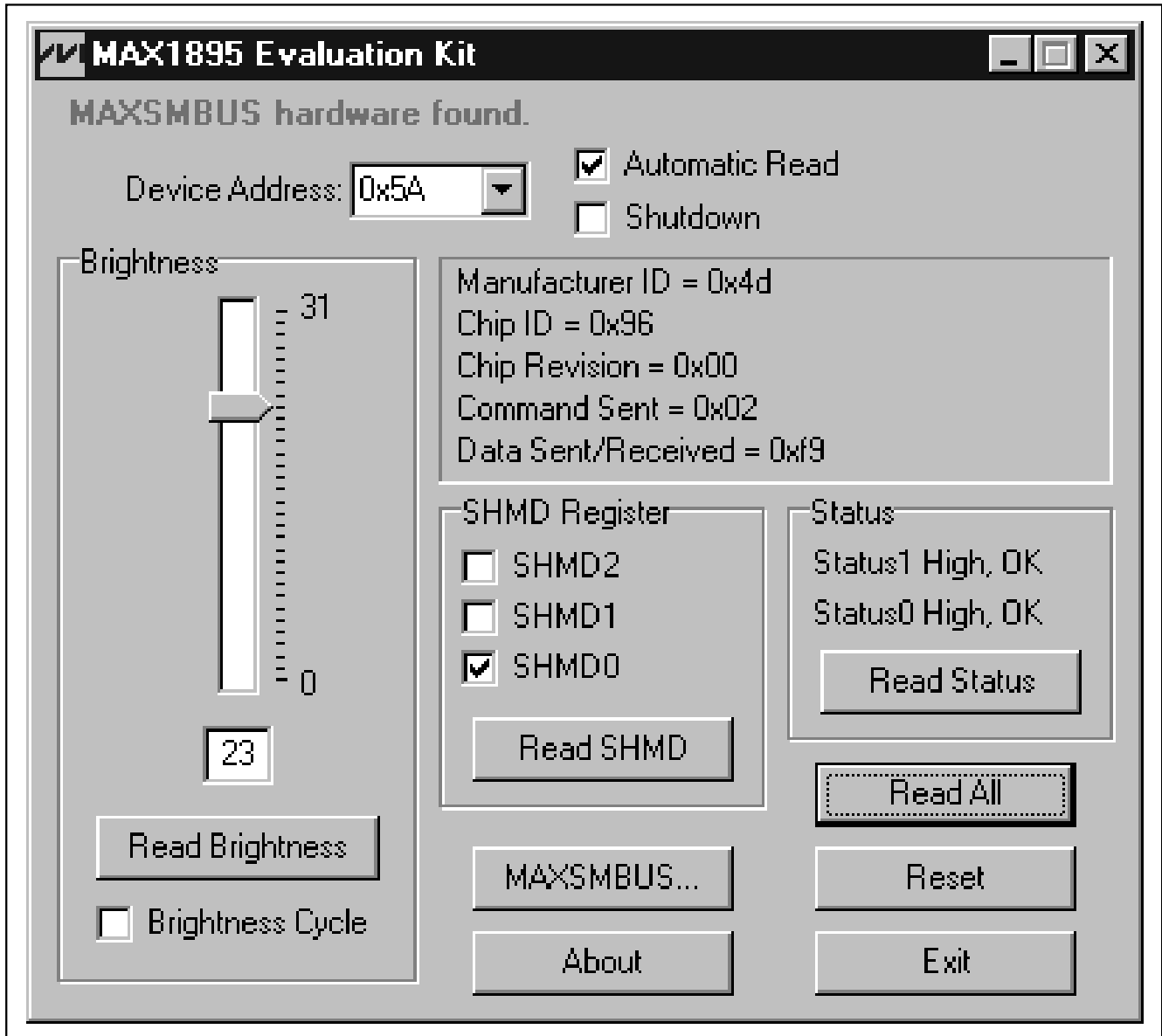

Figure 1. Main Display for MAX1895EVKIT



# MAX1895 Evaluation Systems

Evaluate: MAX1895/MAX1995

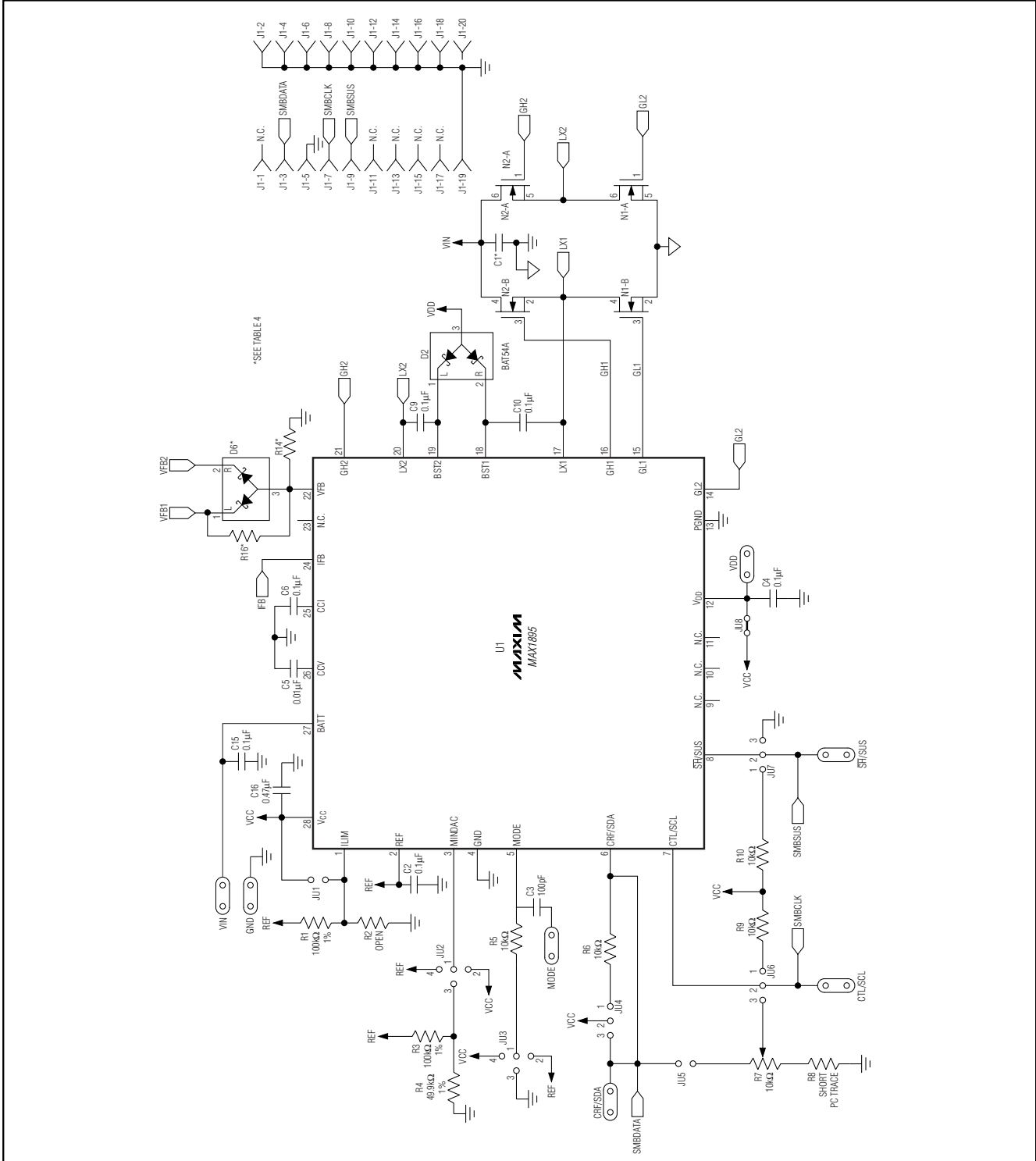

Figure 2. MAX1895 EV Kit Schematic

# MAX1895 Evaluation Systems

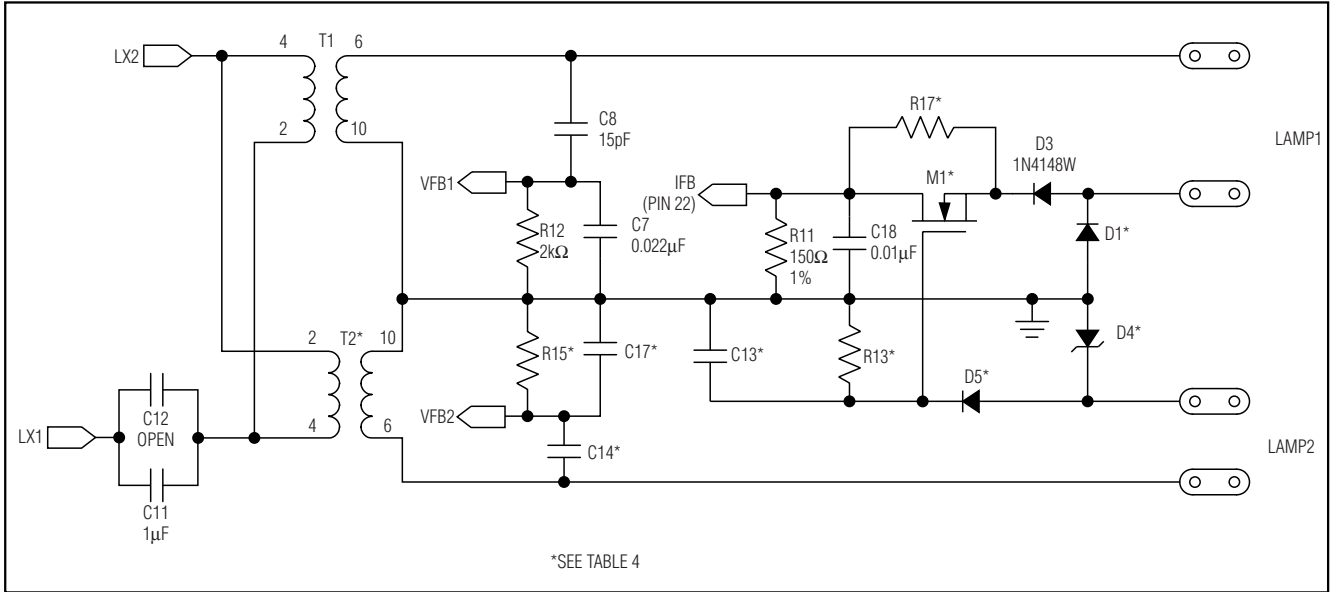

Figure 3. MAX1895 EV Kit Schematic—High-Voltage Section

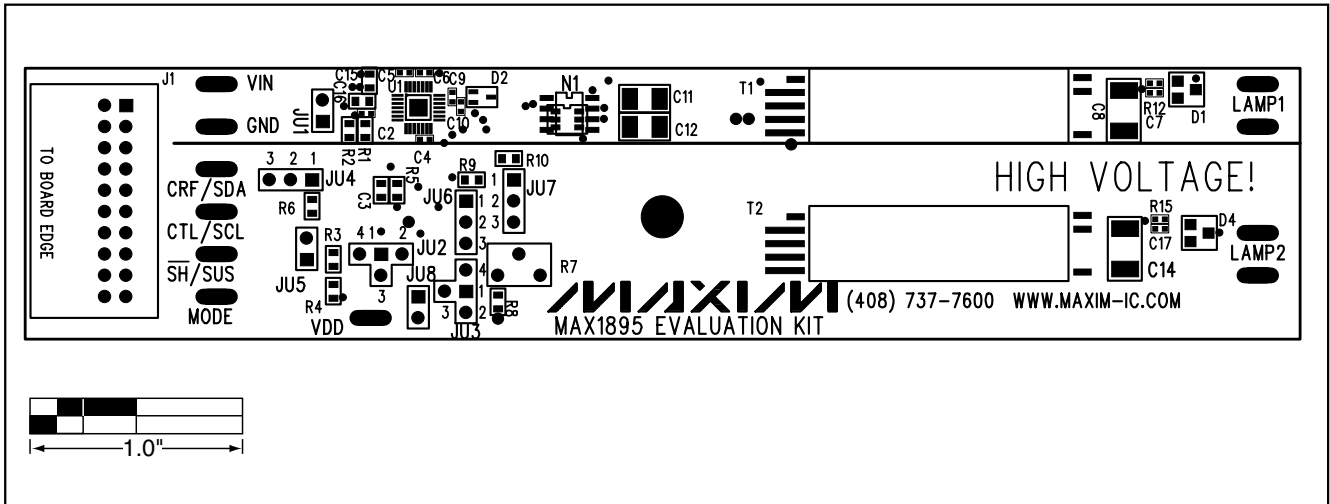

Figure 4. MAX1895 EV Kit Component Placement Guide—Component Side

# MAX1895 Evaluation System

Evaluates: MAX1895

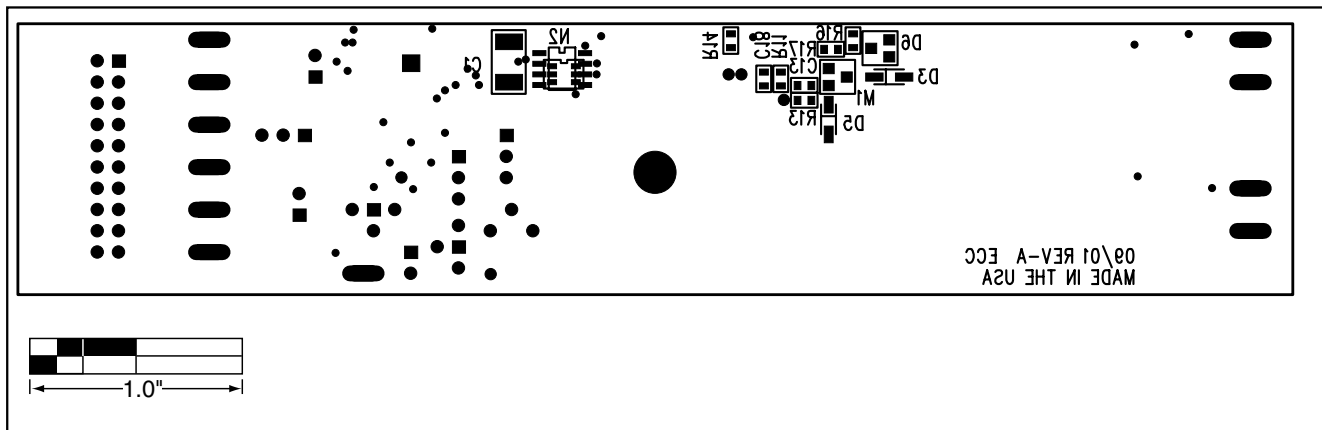

Figure 5. MAX1895 EV Kit Component Placement Guide—Solder Side

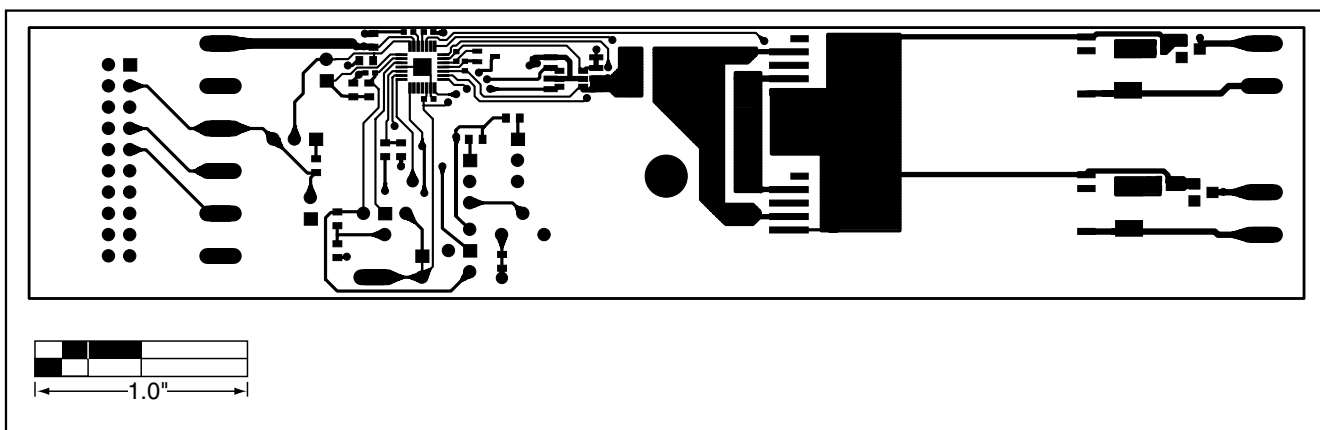

Figure 6. MAX1895 EV Kit PC Board Layout—Component Side

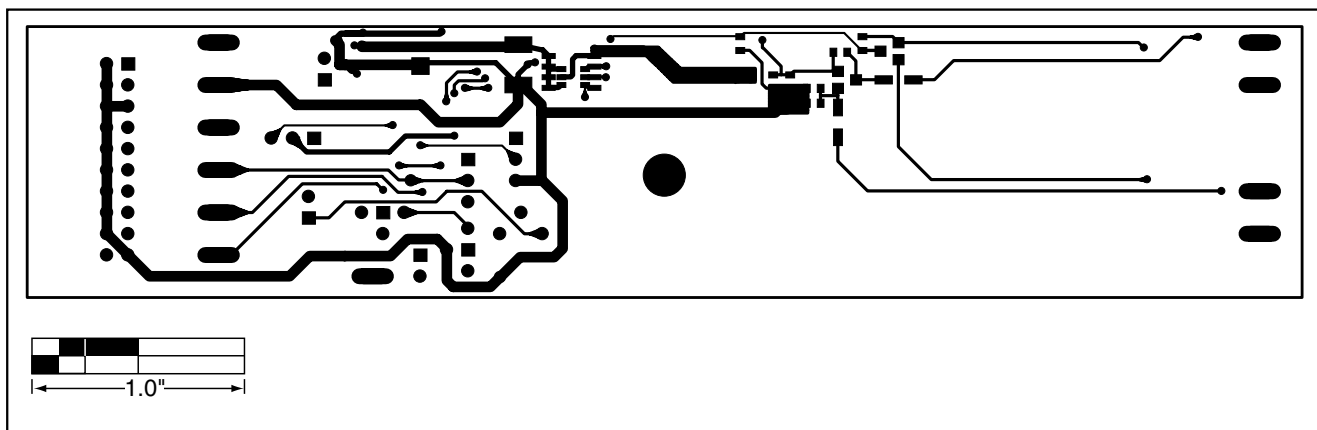

Figure 7. MAX1895 EV Kit PC Board Layout—Solder Side

Maxim cannot assume responsibility for use of any circuitry other than circuitry entirely embodied in a Maxim product. No circuit patent licenses are implied. Maxim reserves the right to change the circuitry and specifications without notice at any time.

Maxim Integrated Products, 120 San Gabriel Drive, Sunnyvale, CA 94086 408-737-7600 \_\_\_\_\_ 11